



HOLLYWOOD BED & SPRING MFG. CO., INC.

Tel: (323) 887-9500 Fax: 323-887-9555



BEDDING SUPPORT PRODUCTS PORTFOLIO

- Bed Frames
- Rollaway Beds
- Dynamic Metal Bed Bases
- Bed Rails
- Center Supports
- Daybed Hardware
- Accessories



*Since 1925...
The best bedding
support products*

Hollywood Bed & Spring Mfg. Co., Inc.



Hollywood Bed has been a leading supplier of bedding support products to the home furnishing, hospitality, contract and government markets for more than 80 years. As a family owned business, we are aware that we must meet and exceed the expectations of our customers. Thus, we are committed to providing quality products, value priced, with unparalleled customer service.

Hollywood Bed manufactures a variety of products including: metal bed frames, bed rails, center support systems, rollaway beds, metal bed bases, high-risers, daybed hardware and accessories. In addition, we design and distribute a style-conscious line of beds, daybeds and upholstered headboards. Quality, durability, ease of assembly and safety are characteristics of our products.

Our goal is to create a program that will provide products that fulfill your needs, while keeping your inventories at manageable levels. We would be pleased to work together to achieve your objective.

The years ahead herald a period of development and growth and we look forward to the opportunity to service your business.

Thank you for taking the time to review our portfolio of bedding support products.

TABLE OF CONTENTS

Holly-Matic® Bed Frames	pg. 3	Bed Rails & Center Supports	pg. 9
Premium Lev-R-Lock® Bed Frames	pg. 4	Rollaway Beds	pg. 10
Deluxe Lev-R-Lock® Bed Frames	pg. 5	Dynamic Metal Bed Bases™	pg. 11
Atlas-Lock™ Bed Frames	pg. 6	High Riser & Daybed Hardware	pg. 12
Classic Clamp Style Bed Frames	pg. 7	Accessories	pg. 13
Standard Bed Frames	pg. 8	Jay Michael Designs	pg. 14

Holly-Matic Bed Frames

THE HOLLY-MATIC® BED FRAME

THE STRONGEST BED FRAME ON EARTH!

An Extra Heavy Duty Bed Frame... easy to assemble, no tools.

EXCLUSIVE FEATURES:

- Strong enough for ALL Bedding
- Heavy-Duty Steel Construction
- Oversize 1 3/4" x 1 3/8" High Carbon Rail Steel Side Rails for Solid Support
- Wedge Lock™ Leg Design - Becomes Stronger with Use
- Solid Rivet Construction
- Recessed Legs for Additional Toe Room

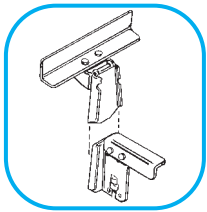

Wedge Lock™ Leg Design

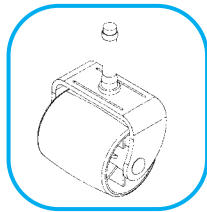

2-1/2" Rug Rollers

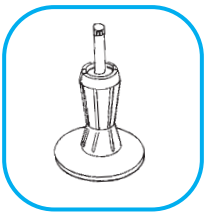

Steel Stem Glide

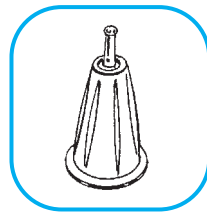

10" High Profile
Glide

7 1/2" Height with 2 1/2" Rug Rollers

Model #	Size	Legs
4034 BR	Twin (XL)	4
4044 BR	Full (XL)	4
4056 BR	Queen	6
4066 BR	Cal. King	6
4166 BR	East. King	6

7 1/2" Height with Steel Stem Glides

Model #	Size	Legs
4034 BG	Twin (XL)	4
4044 BG	Full (XL)	4
4056 BG	Queen	6
4066 BG	Cal. King	6
4166 BG	East. King	6

7 1/2" Height Headboard & Footboard Steel Stem Glides

Model #	Size	Legs
4034 HFG	Twin (XL)	4
4044 HFG	Full (XL)	4
4056 HFG	Queen	6
4066 HFG	Cal. King	6
4166 HFG	East. King	6

10" Height with High-Profile Glide

Model #	Size	Legs
4034 BG-10	Twin (XL)	4
4044 BG-10	Full (XL)	4
4056 BG-10	Queen	6
4066 BG-10	Cal. King	6
4166 BG-10	East. King	6

MULTI-FIT HOLLY-MATIC (ONE SIZE FITS ALL)

6556 BR Twin /Full /Queen /Cal. King /East. King - Headboard Attachment

Lev-R-Lock Bed Frames

THE PREMIUM LEV-R-LOCK® BED FRAME

OUR MOST POPULAR PATENTED ADJUSTABLE BED FRAME

- Patent #5,161,286
- Heavy Duty 1 1/2" x 1 1/2" High Carbon Rail Steel Side Rails
- Recessed Tubular Legs with Super Leg Lock Construction
- Solid Rivet Construction
- Fast, Easy Assembly
- Heavy Duty Headboard Brackets
- Large 2 1/2" Rug Rollers, 2 with Brakes

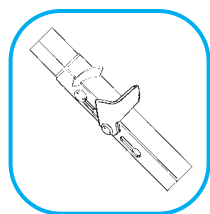

Lev-R-Lock



Triple Thick Steel Leg Construction

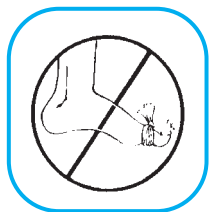

Anti-Stubbing Recessed Legs

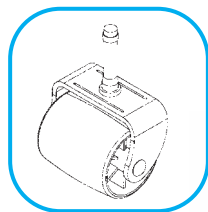

2-1/2" Rug Rollers



3260BR
Twin/Full
Rug Rollers
(Shown)



3265BR
Twin/Full/Queen
Rug Rollers
(Shown)



3270BR
Queen/Cal. King/East King
Rug Rollers
(Shown)

Premium Lev-R-Lock Frames w/Headboard Attachments

Model #	Size	Legs	Wheels/Glides
3260 BR	Twin/Full (XL)	4	2 1/2" Rug Rollers, 2 w/Brakes
3265 BR	Twin/Full/Queen	5	2 1/2" Rug Rollers, 2 w/Brakes
3270 BR	Queen/Cal.King/East.King	6	2 1/2" Rug Rollers, 2 w/Brakes

Premium Lev-R-Lock Frames w/Headboard Attachments

Model #	Size	Legs	Wheels/Glides
3260 BSG	Twin/Full (XL)	4	Steel Stem Glides
3265 BSG	Twin/Full/Queen	5	Steel Stem Glides
3270 BSG	Queen/Cal.King/East.King	6	Steel Stem Glides

Low Profile Bed Frame 4 1/2" Height (ONE SIZE FITS ALL)

6356 LPR Twin /Full /Queen /Cal. King /East. King - 6 Legs, 2 1/2" Rug Rollers 2 with Brakes

Deluxe Lev-R-Lock Bed Frames

THE DELUXE LEV-R-LOCK® BED FRAME

OUR MOST POPULAR ADJUSTABLE BED FRAME

- Patent #5,161,286
- 1 1/4" x 1 1/4" High Carbon Rail Steel Side Rails
- Recessed Tubular Legs with Super Leg Lock Construction
- Solid Rivet Construction
- Fast, Easy Assembly
- Heavy Duty Headboard Brackets
- Large 2" Wide Rug Rollers

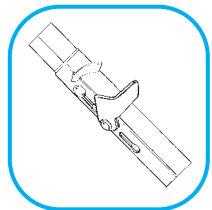

Lev-R-Lock

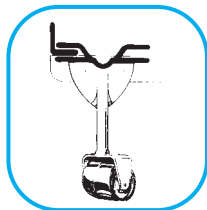

Triple Thick Steel
Leg Construction

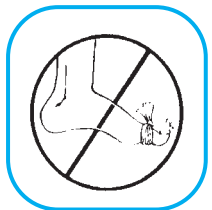

Anti-Stubbing
Recessed Legs

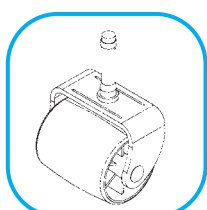

Wide Roller



3050BL
Twin/Full
with 2" Wide Rollers
(Shown)



3065BL
Twin/Full/Queen
with 2" Wide Rollers
(Shown)



3070BL
Queen/Cal. King/East King
with 2" Wide Rollers
(Shown)

Deluxe Lev-R-Lock Frames w/Headboard Attachments

Model #	Size	Legs	Wheels/Glides
3050 BL	Twin/Full	4	2" Wide Rollers
3060 BL	Twin/Full/Queen	4	2" Wide Rollers
3065 BL	Twin/Full/Queen	5	2" Wide Rollers
3070 BL	Queen/Cal. King/East King	6	2" Wide Rollers

(ONE SIZE FITS ALL)

6156 BL Twin /Full /Queen /Cal. King /East. King - 6 Legs, 2" Wide Rollers

THE ATLAS-LOCK™ BED FRAME

OUR MOST ECONOMICAL ADJUSTABLE BED FRAME

- Patented Locking System #6, 415, 465 B1
- Adjustable Keyhole Design
- 1 1/4" x 1 1/4" High Carbon Rail Steel Side Rails
- Recessed Tubular Legs with Super Leg Lock Construction
- Solid Rivet Construction
- Fast, Easy Assembly
- Heavy Duty Headboard Attachments

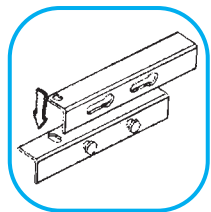

Atlas Lock

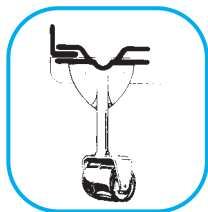

Triple Thick Steel Leg Construction

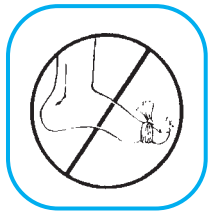

Anti-Stubbing Recessed Legs

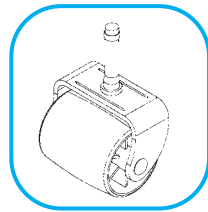

Wide Roller



3150BL
Twin/Full
with 2" Wide Rollers
(Shown)



3165BL
Twin/Full/Queen
with 2" Wide Rollers
(Shown)



3170BL
Queen/Cal. King/East King
with 2" Wide Rollers
(Shown)

Atlas-Lock Frames w/Headboard Attachments

Model #	Size	Legs	Wheels/Glides
3150 B	Twin/Full	4	1 5/8" Casters
3150 BL	Twin/Full	4	2" Wide Rollers
3160 BL	Twin/Full/Queen	4	2" Wide Rollers
3165 BL	Twin/Full/Queen	5	2" Wide Rollers
3170 BL	Queen/Cal.King/East.King	6	2" Wide Rollers

CLASSIC CLAMP STYLE BED FRAME

ADJUSTABLE BED FRAME

Most Versatile Bed Frame

- 1 1/4" x 1 1/4" High Carbon Rail Steel Side Rails
- Adjustable with a Heavy Duty Clamp
- Easily adjusts to all Bedding Sizes - Regular or Odd
- Solid Rivet Construction
- Heavy Duty Headboard Attachments



Assembly with Clamp

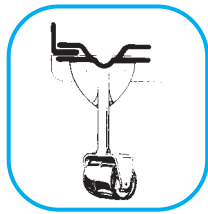

Triple Thick Steel Leg Construction

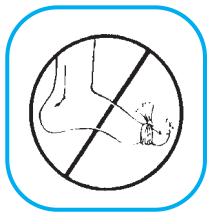

Anti-Stubbing Recessed Legs

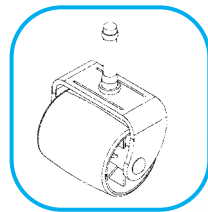

Wide Roller



1057BL
Twin/Full
with 2" Wide Rollers
(Shown)



1870BL
Queen/Cal. King/East King
with 2" Wide Rollers
(Shown)

Clamp Style Bed Frame w/Headboard Attachments

Model #	Size	Legs	Wheels/Glides
1057 B	Twin/Full	4	1 5/8" Casters
1057 BL	Twin/Full	4	2" Wide Rollers
1800 BQL	Twin/Full/Queen	4	2" Wide Rollers
1870 BL	Queen/Cal.King/East.King	6	2" Wide Rollers
1105 BSG *	Queen/Cal.King/East.King	9	Super Glides

* For Waterbeds

STANDARD BED FRAME

NON-ADJUSTABLE BED FRAME

A Value Frame

- 1 1/4" x 1 1/4" High Carbon Rail Steel Side Rails
- Easy Assembly with Nuts & Bolts
- Durable Design and Quality
- Recessed Tubular Legs with Super Leg Lock Construction
- Solid Rivet Construction
- Heavy Duty Headboard Attachment
Available with Headboard / Footboard Attachments

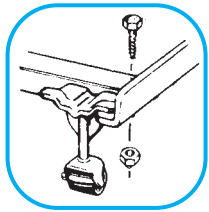

Nut & Bolt Assembly

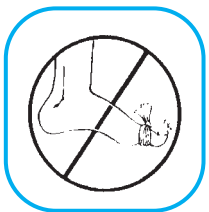

Anti-Stubbing
Recessed Legs

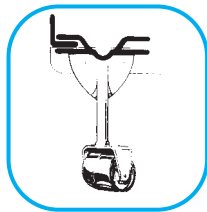

Triple Thick Steel
Leg Construction

Standard Bed Frame w/Headboard Attachments

Model #	Size	Legs	Wheels/Glides
1203 B	Twin	4	1 5/8" Casters
1203 BL	Twin	4	2" Wide Rollers
1204 B	Full	4	1 5/8" Casters
1204 BL	Full	4	2" Wide Rollers
1205 B	Queen	5	1 5/8" Casters
1205 BL	Queen	5	2" Wide Rollers
1206 B	Queen/Cal.King/East.King	6	1 5/8" Casters
1206 BL	Queen/Cal.King/East.King	6	2" Wide Rollers

Headboard / Footboard with Adjustable Glide

Model #	Size	Legs	Wheels/Glides
1234 HF	Twin/Full (XL)	4	Adjustable Glides
1205 HF	Queen	5	Adjustable Glides
1206 HF	Queen/East.King	6	Adjustable Glides
1207 HF	Cal.King	6	Adjustable Glides

BED RAILS AND CENTER SUPPORTS

DESIGNED TO PROVIDE STRENGTH AND RIGIDITY AT THE HEAD AND FOOT

EXCLUSIVE FEATURES:

- Heavy Gauge High Carbon Rail Steel Side Rails
- Heavy Gauge Bolt-On or Hook-In Brackets
- Center Support Available for Added Strength
- Solid Rivet Construction



KH18
Center Support
Queen/Cal. King/ East. King
2 Cross Supports
6 Legs

498R
Cal. King Center Support
Cross Arms, 2 Legs
Adjustable Glides

445S
Queen/Cal. King/ East. King
Center Support
2 Legs

415BOR
Twin/Full with 2
Cross Arms

Hook In Bed Rails

Model #	Description
400 R	76" Twin/Full
410 R	82" Queen
98Q R	82" Queen with Cross Arm, 1 Leg, Adj. Glide
490 R	82" Queen/East.King, Center Support, Crossarms, 2 Legs, Adj. Glides
498 R	86" Cal. King, Center Support, Crossarms, 2 Legs, Adj. Glides

Bolt On Bed Rails

Model #	Description
400 BOR	76" Twin/Full
401 BOR	76" Twin/Full with 2 Cross Ties
415 BOR	76" Twin/Full with 2 Cross Arms
410 BOR	82" Queen
425 BOR	82" Queen with 2 Cross Arms
98Q BOR	82" Queen with Cross Arm, 1 Leg, Adj. Glide
490 BOR	82" Queen/East.King, Center Support, Crossarms, 2 Legs, Adj. Glides
498 BOR	86" Cal. King, Center Support, Crossarms, 2 Legs, Adj. Glides

Center Support Bed Rails

Model #	Description
445 S	7"-10" Queen/King Center Support, 2 Legs
QH -11	7"-11" Full/Queen, 2 Cross Support, 4 Legs
KH -11	7"-11" Queen/King, 2 Cross Support, 6 Legs
KH -18	7"-18" Queen/King, 2 Cross Support, 6 Legs

HOLLYWOOD ROLLAWAY BEDS

HEAVY DUTY HIGH CARBON ANGLE STEEL ROLLAWAY BEDS DESIGNED FOR COMFORT AND DURABILITY

- Automatic Leg Opening
- 2" Ball Bearing Wheels
- Rounded Corners... Firmly Braced and Engineered for trouble free use
- Double Strand Wire Link Fabric with 12 Gauge Tight Wound Helical Springs for proper mattress support
- Available in 3 Popular Widths (30, 39 & 48 inches)
- Quality Polyfoam or Innerspring Mattress



950 30" POLY
with Polyfoam Mattress
(shown)



950 39" SPG
with Innerspring Mattress
(shown)

#950 Rollaway Beds

Model #	Description
950 30" POLY	with Polyfoam Mattress
950 30" SPG	with Innerspring Mattress
950 30" METAL	Metal Frame Only
950 39" POLY	with Polyfoam Mattress
950 39" SPG	with Innerspring Mattress
950 39" METAL	Metal Frame Only
950 48" POLY	with Polyfoam Mattress
950 48" SPG	with Innerspring Mattress
950 48" METAL	Metal Frame Only

Mattress Only

Model #	Description
24-1001	30" Polyfoam
24-1002	39" Polyfoam
24-1003	48" Polyfoam
24-1004	30" Innerspring
24-1005	39" Innerspring
24-1006	48" Innerspring

DYNAMIC METAL BED BASE™

ALL STEEL CONSTRUCTION, PROVIDES THE SAFEST AND STRONGEST SUPPORT

EXCLUSIVE FEATURES:

- Patents: 6,925,666 B2 • 6,865,758 B2 • 7,155,762
- Securing Top and Bottom Corner Brackets
- Keyhole Corner Attachment for Fast and Easy Assembly
- Strong Center Supports
- Brown Powder Coated Finish
- 9 legs on Queen, California King, and Eastern King
6 legs on Twin and Full

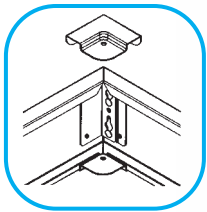

Securing top and bottom corner brackets

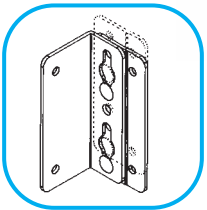

Keyhole corner attachment plate

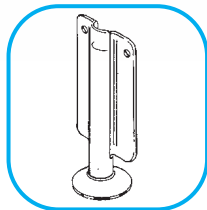

Heavy duty leg with glide

6" Height		
Model #	Size	Legs
M630 T	TWIN (XL)	6
M640 F	FULL (XL)	6
M650 Q	QUEEN	9
M660 CK	C. KING	9
M666 EK	E. KING	9

7 1/2" Height		
Model #	Size	Legs
M730 T	TWIN (XL)	6
M740 F	FULL (XL)	6
M750 Q	QUEEN	9
M760 CK	C. KING	9
M766 EK	E. KING	9

10" Height		
Model #	Size	Legs
M1030 T	TWIN (XL)	6
M1040 F	FULL (XL)	6
M1050 Q	QUEEN	9
M1060 CK	C. KING	9
M1066 EK	E. KING	9

HIGH RISER AND DAYBED HARDWARE

SUPERIOR DAYBED HARDWARE FOR ALL TYPES OF DAYBEDS

Top Spring (Link Spring) #138

- Designed and Engineered for Comfort and Total Mattress Support
- Top Springs made with High Carbon Rail Steel
- 39" Wire Link Fabric
Down (BD) Center (C) Brackets



Pop-Up Trundle #38P (39" Link Fabric)

- Heavy Duty E-Z Lift Spring
- Safety Locks in both Raised and Closed Position
- Cross-Braces Provide Extra Support
- Made with High Carbon Rail Steel



High Riser #41J

- Combines Top Spring with Fold Under Legs and Pop-Up Trundle
- Legs are permanently attached to Top Spring for easy assembly



Pull-Out Trundle #339T (39" Link Fabric)

- Remains in Lowered Position
- Rug Rollers for easy Movement
- Made with High Carbon Rail Steel Construction

Hollywood Bed Accessories



#65R Hook In Display Rails (Pair)
#65 BOR Bolt-On Display Rails (Pair)

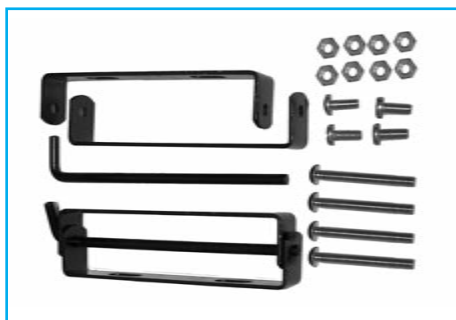

#71 Swivel Bracket Kit

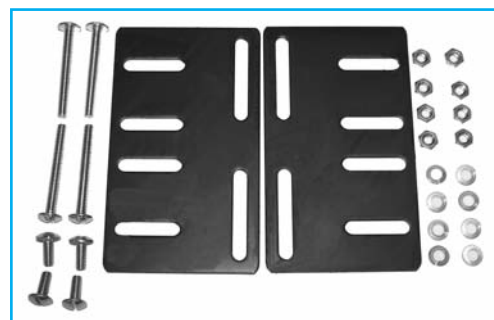

#72 Extension Plates (Pair)



#75 Adjustable Hooks (Pair)



#80 Bolt on Brackets (Pair)



20-1009
Threaded Insert



20-1010
1 1/4" End Cap



20-1011
1 1/2" End Cap



20-1013
Insert



19-1034
Center Glide



#94 2 Part Glide
for Holly-Matic



#97 Adjustable Glide
& Insert



19-1013 Low Boy Glide



19-1032 3" Superglide
w/ Stem & Insert



19-1035 10" Glide
for Holly-Matic



19-1015 2 1/2" Rug Roller



19-1017 2" Wide Roller



19-1018 1 5/8" Caster



19-1024 2 1/2" Rug Roller
with Brake



19-1025 Rollaway Caster
with Brake

ACCESSORIES NOT SHOWN

64 - Safety wire-cross tie
73 - 1" x 1" Screw with Clamp
74 - 1/4" x 2 1/4" Screws & Nuts (100)

85 - Pop Up Connection (Pair)
703 - Twin Canopy Frame
704 - Full Canopy Frame

1400 - Mirror Support 48" (Doz)
1600 - Mirror Support 60" (Doz)



Manhattan Bed



Andrea Bed

Jay Michael Designs

Jay Michael Designs is a style-conscious line of Iron, Wood and Mixed Media Beds, Upholstered Headboards and Daybeds. They are all developed, designed and distributed by Hollywood Bed & Spring Mfg. Co., Inc.

Our unique styles, finishes and attention to detail assure customers of the best overall value in the industry.

Jay Michael Design products utilize our unique Threaded Bracket Plate for durability and ease of assembly.

All of our beds, headboards and daybeds are inventoried at our warehouse in Commerce, CA and are available for immediate shipment. We also offer Container Direct Programs.

For more information, visit www.hollywoodbed.com or contact your Sales Representative or our Customer Service Advisors.



Janice Daybed



Evelyn Daybed



BEDDING SUPPORT PRODUCTS PORTFOLIO



HOLLYWOOD BED & SPRING MFG. CO., INC.

5959 Corvette Street • Commerce, CA 90040
e-mail: info@hollywoodbed.com • www.hollywoodbed.com
(800) 228-8831 (323) 887-9500 Fax: 323-887-9555